

# Banana Plug

25.101. \*

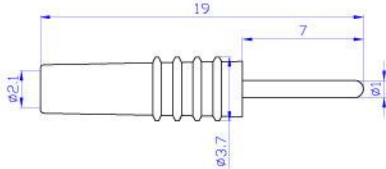

**Material**  
 Insulator:PVC  
 Body:Brass  
 Surface:Gold plated  
 \*Solder connection  
**Rated voltage/current**  
 30Vac-60Vdc/Max.6A



25.204. \*



**Material**  
 Insulator:PE  
 Body:Brass  
 Surface:Nickel plated  
 \*Solder connection  
**Rated voltage/current**  
 30Vac-60Vdc/Max.10A

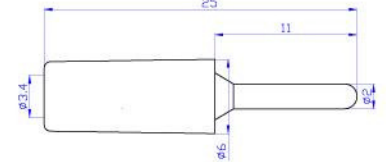

25.201. \*



**Material**  
 Insulator:PVC  
 Body:Brass  
 Spring:Beryllium copper  
 Surface:Gold plated  
 \*Solder connection  
**Rated voltage/current**  
 30Vac-60Vdc/Max.10A

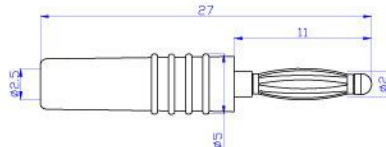

25.205. \*



**Material**  
 Insulator:PVC  
 Body:Brass  
 Spring:Beryllium copper  
 Surface:Gold plated  
 \*Solder connection  
**Rated voltage/current**  
 30Vac-60Vdc/Max.10A

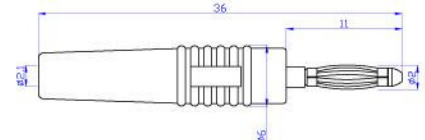

25.202. \*



**Material**  
 Insulator:PE  
 Body:Brass  
 Spring:Beryllium copper  
 Surface:Gold plated  
 \*Solder connection  
**Rated voltage/current**  
 30Vac-60Vdc/Max.12A

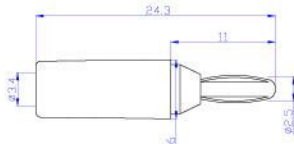

25.206. \*



**Material**  
 Insulator:PE  
 Body:Brass  
 Spring:Beryllium copper  
 Surface:Gold plated  
 \*Solder connection  
**Rated voltage/current**  
 30Vac-60Vdc/Max.10A

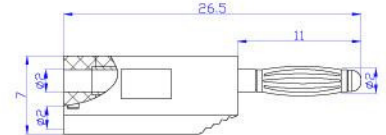

25.203. \*



**Material**  
 Insulator:PE  
 Body:Brass  
 Spring:Beryllium copper  
 Surface:Gold plated  
 \*Solder connection  
**Rated voltage/current**  
 30Vac-60Vdc/Max.10A

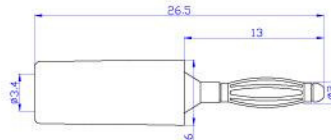

25.207. \*



**Material**  
 Insulator:PE  
 Body:Brass  
 Spring:Beryllium copper  
 Surface:Gold plated  
 \*Solder connection  
**Rated voltage/current**  
 30Vac-60Vdc/Max.10A

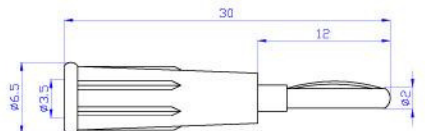

25.208. \*



**Material**  
 Insulator:PA  
 Body:Brass  
 Spring:Beryllium copper  
 Surface:Nickel plated  
 \*Solder connection  
**Rated voltage/current**  
 CATII 600V/Max.10A

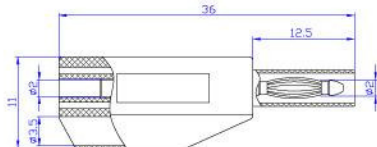

25.410. \*



**Material**  
 Insulator:PVC  
 Body:Brass  
 Spring:Steel  
 Surface:Nickel plated  
 \*Screw connection  
**Rated voltage/current**  
 30Vac-60Vdc/Max.24A

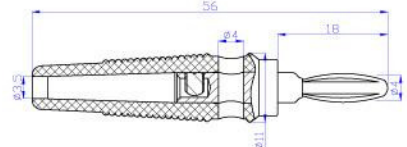

25.401. \*



**Material**  
 Insulator:ABS  
 Body:Brass  
 Spring:Beryllium copper  
 Surface:Nickel plated  
 \*Screw connection  
**Rated voltage/current**  
 30Vac-60Vdc/Max.24A

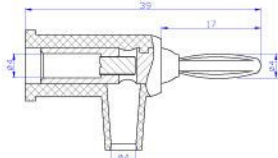

25.411. \*



**Material**  
 Insulator:PVC  
 Body:Brass  
 Spring:Steel  
 Surface:Nickel plated  
 \*Screw connection  
**Rated voltage/current**  
 30Vac-60Vdc/Max.24A

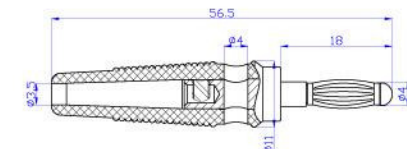

25.402. \*



**Material**  
 Insulator:ABS  
 Body:Brass  
 Spring:Phosphorus copper  
 Surface:Nickel plated  
 \*Solder connection  
**Rated voltage/current**  
 30Vac-60Vdc/Max.19A

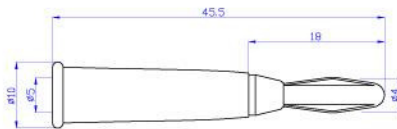

25.412. \*



**Material**  
 Insulator:PVC  
 Body:Brass  
 Spring:Beryllium copper  
 Surface:Nickel plated  
 \*Screw connection  
**Rated voltage/current**  
 30Vac-60Vdc/Max.24A

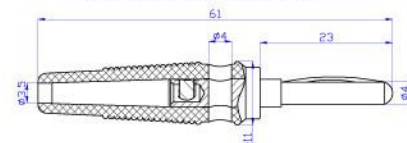

25.403. \*



**Material**  
 Insulator:PE  
 Body:Brass  
 Spring:Beryllium copper  
 Surface:Nickel plated  
 \*Screw connection  
**Rated voltage/current**  
 30Vac-60Vdc/Max.32A

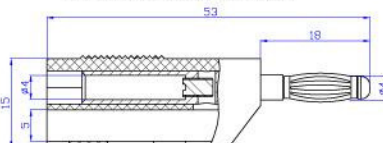

25.413. \*



**Material**  
 Insulator:PVC  
 Body:Brass  
 Spring:Phosphorus copper  
 Surface:Nickel plated  
 \*Screw connection  
**Rated voltage/current**  
 30Vac-60Vdc/Max.32A

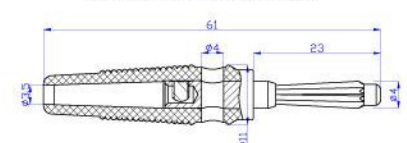

25.414. \*



**Material**  
 Insulator:PVC  
 Body:Brass  
 Surface:Nickel plated  
 \*Screw connection  
**Rated voltage/current**  
 30Vac-60Vdc/Max.32A

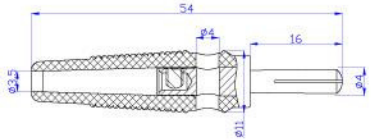

25.422. \*



**Material**  
 Insulator:PA  
 Body:Brass  
 Spring:Beryllium copper  
 Surface:Gold plated  
 \*Solder connection  
**Rated voltage/current**  
 30Vac-60Vdc/Max.24A

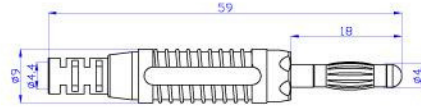

25.415. \*



**Material**  
 Insulator:PVC  
 Body:Brass  
 Surface:Nickel plated  
 \*Screw connection  
**Rated voltage/current**  
 30Vac-60Vdc/Max.24A

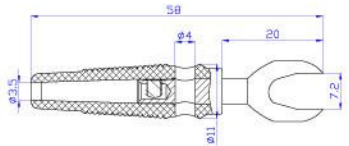

25.425. \*



**Material**  
 Insulator:PE  
 Body:Beryllium copper  
 Spring:Beryllium copper  
 Surface:Gold plated  
 \*Solder connection  
**Rated voltage/current**  
 30Vac-60Vdc/Max.19A

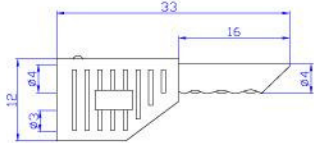

25.420. \*



**Material**  
 Insulator:ABS  
 Body:Brass  
 Surface:Nickel plated  
 \*Screw connection  
**Rated voltage/current**  
 30Vac-60Vdc/Max.24A

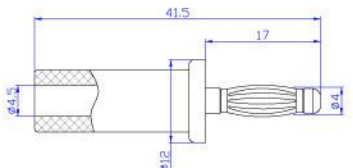

25.426. \*



**Material**  
 Insulator:PE  
 Body:Brass  
 Spring:Steel  
 Surface:Nickel plated  
 \*Solder connection  
**Rated voltage/current**  
 30Vac-60Vdc/Max.19A

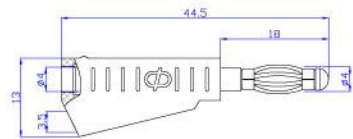

25.421. \*



**Material**  
 Insulator:ABS  
 Body:Brass  
 Surface:Nickel plated  
 \*Solder connection  
**Rated voltage/current**  
 30Vac-60Vdc/Max.24A

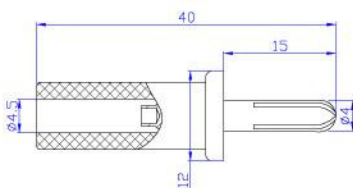

25.430. \*



**Material**  
 Insulator:PVC  
 Body:Brass  
 Surface:Nickel plated  
 \*Screw connection  
**Rated voltage/current**  
 30Vac-60Vdc/Max.24A

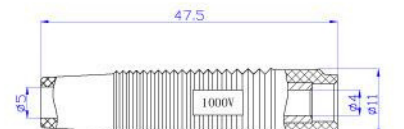

25.431. \*



**Material**

Insulator:PA  
Body:Brass  
Surface:Nickel plated  
\*Solder connection

**Rated voltage/current**  
30Vac-60Vdc/Max.24A

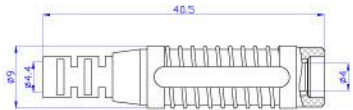

25.502. \*



**Material**

Insulator:PA  
Body:Brass  
Spring:Beryllium copper  
Surface:Nickel plated  
\*Solder connection

**Rated voltage/current**  
CATII 1000V/Max.32A

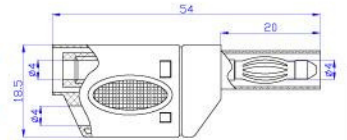

25.450. \*



**Material**

Insulator:PA  
Body:Brass  
Spring:Beryllium copper  
Surface:Nickel plated  
\*Solder connection

**Rated voltage/current**  
CATII 600V/Max.32A

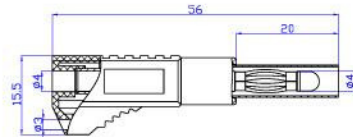

25.503. \*



**Material**

Insulator:PA  
Body:Brass  
Spring:Beryllium copper  
Surface:Nickel plated  
\*Solder connection

**Rated voltage/current**  
CATII 1000V/Max.32A

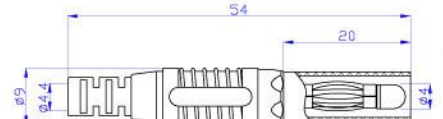

25.451. \*



**Material**

Insulator:PA  
Body:Brass  
Spring:Beryllium copper  
Surface:Nickel plated  
\*Press connection

**Rated voltage/current**  
30Vac-60Vdc/Max.32A

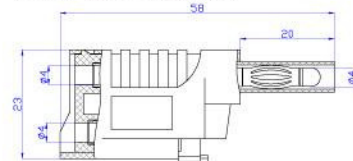

25.504. \*



**Material**

Insulator:PA  
Body:Brass  
Spring:Beryllium copper  
Surface:Nickel plated  
\*Solder connection

**Rated voltage/current**  
CATII 1000V/Max.32A

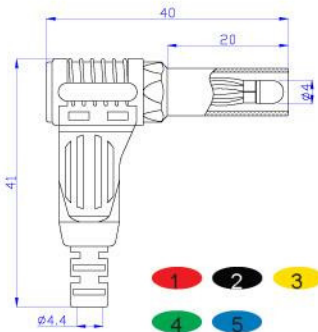

25.501. \*



**Material**

Insulator:PA  
Body:Brass  
Spring:Beryllium copper  
Surface:Nickel plated  
\*Solder connection

**Rated voltage/current**  
CATII 600V/Max.32A

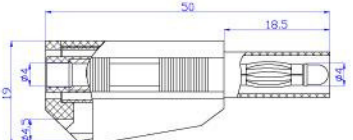

25.505. \*



**Material**

Insulator:PA  
Body:Brass  
Surface:Nickel plated  
\*Solder connection

**Rated voltage/current**  
CATII 600V/Max.19A

